

SPECIFICATIONS

DESCRIPTION	IR RECEIVER MODULE
SPECIFICATION	
MAKER SPECIFICATION	R94FC2A
CODE No.	
MODEL No.	
SPECIAL ARTICLES	

MANAGER	CHECK	APPROVAL
A TERM OF VALIDITY	YEAR	

MAKER	OPTO ELECTRONICS CO., LTD (HEAD QUARTER & KOREA FACTORY)	82-63-433-4566
ADDRESS	1066-12 YOUNJANG-RI, JINAN-UP, JINAN-GUN, JEON-BUK, KOREA.	
MAKER	China(Dalian) OPTO Electronics co., LTD	86-411-8761-4929
ADDRESS	China(Dalian) OPTO Electronics co., LTD No. 2 yian Kou RD Dalian Development Zone C.P.O Box 39	

<h1>SPECIFICATIONS</h1>		SHEET No.	1 of 10
		DATE	2009. 05. 04.
PART NAME	IR RECEIVER MODULE	TYPE No.	R94FC2A
CODE No.		REVISION	A

1. Application

This Specification is applied to inspection and approval of the IR Receiver Module for color TV, DVD, air conditioner and audio equipment

2. Description

The Series are miniaturized receiver for infrared remote control system.

The Pin Photodiode and preamplifier are assembled on lead frame. The epoxy package is designed as IR filter

The module has excellent performance even in disturbed ambient light application and provides protection against uncontrolled output pulses

3. Features





- 1) High ripple rejection
- 2) Wide operating supply voltage 2.7V ~ 6.0V
- 3) Supply current : 3.3V(0.9mA), 5.0V(1.0mA)
- 4) Band pass filter center frequency : 37.9kHz
- 5) Epoxy IR filter characteristic : 940nm
- 6) Maximum interference safety against optical and electrical disturbance
- 7) Internal filter for a high frequency lighting fluorescent lamp.
- 8) Internal Pull-Up output. : 40kΩ

4. Absolute Maximum Ratings

- 1) Supply voltage : 7.0V
- 2) Supply current : 3.0mA
- 3) Operating temperature : -25°C ~ +85°C
- 4) Storage temperature : -40°C ~ +125°C

5. Cautions

- 1) Store and use where there is no force causing transformation or change in quality.
- 2) Store and use where there is no extreme humidity.
- 3) In order to prevent damage from static electricity, make sure that the human body and the soldering iron are connected to ground before using.
- 4) The ripple noise from power supply lines may shorten detecting distance of IR Receiver Module. Thus, in order to ensure more reliable operating please add RC filter (R=100Ω, C=47μF) between Vcc and GND
- 5) When a disturbance signal is applied to the Series, it can still receive the data signal. However, the sensitivity is reduced to the level that no unexpected pulses will occur. Some examples of such disturbance signals which can be suppressed by the Series.
 - ① DC light. (ex. From tungsten lamp or sunlight)
 - ② Continuous signal at center frequency or any other frequency.
 - ③ Signals from fluorescent lamps with electronic ballast with high or low modulation.

 <p>OPTO ELECTRONICS CO., LTD. HEAD OFFICE & FACTORY (KOREA) 1066-12 YOUNJANG-RI, JINAN-UP, JINAN-GUN JEON-BUK, KOREA. TEL : (063) 433-4566~8 FAX : (063) 433-4569 E-mail : poweroec@e-oec.com</p>	MANAGER	CHECK	APPROVAL
			
	FILE No.	OQSS-R-000	

SPECIFICATIONS

SHEET No.	2 of 10
DATE	2009. 05. 04.
TYPE No.	R94FC2A
REVISION	A

PART NAME	IR RECEIVER MODULE
CODE No.	

6. Appearance & Dimensions

1) Package Dimension (Unit : mm)

NOTE

1. Pin config

- ① Vout
- ② GND
- ③ VCC

2. Unspecified tolerance : $\pm 0.3\text{mm}$

3. Lead edge finish : Solder dip

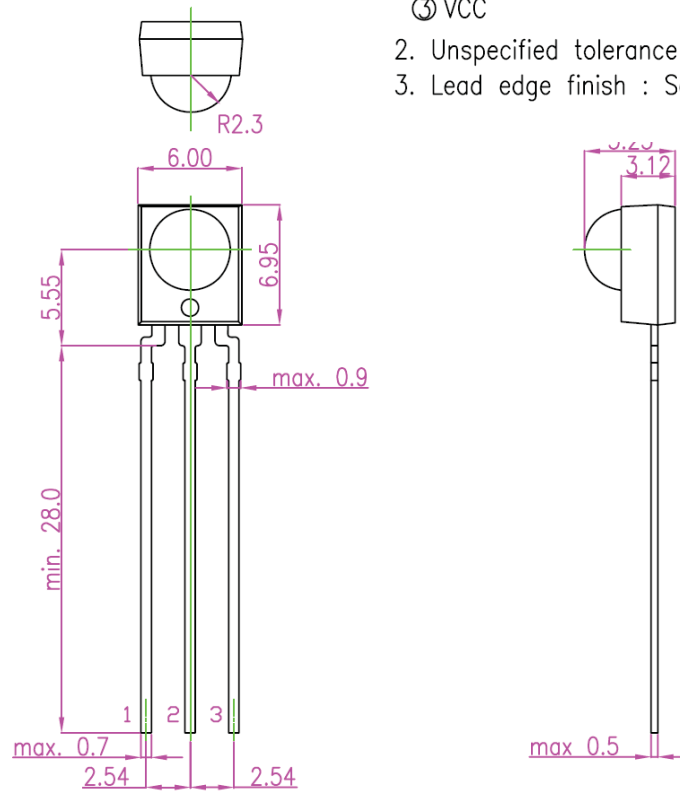

2) Ink-marking on IR receiver module

3) All shield cased module of example...

No.	Specification	Remark
①	Year	0~9
②	Month	A~L(1~12)
③	Date	01~31
④	Lot No.	01~99



OPTO ELECTRONICS CO., LTD.

HEAD OFFICE & FACTORY (KOREA)

1066-12 YOUNJANG-RI, JINAN-UP, JINAN-GUN
JEON-BUK, KOREA.

TEL : (063) 433-4566~8 FAX : (063) 433-4569

E-mail : poweroec@e-oec.com

MANAGER	CHECK	APPROVAL
FILE No.	OQSS-R-000	

SPECIFICATIONS

SHEET No.	3 of 10
DATE	2009. 05. 04.
TYPE No.	R94FC2A
REVISION	A

PART NAME	IR RECEIVER MODULE
CODE No.	

7. Schematic Diagram

1) Internal structure figure

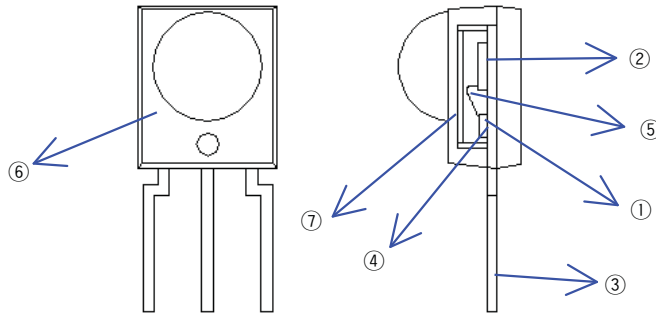

No.	Part name	Materials(method)
①	Pre-amp IC	Silicone
②	Pin Photo Diode	Silicone
③	Frame	Fe Alloy(external lead : Solder dipping)
④	Die Attach	Ag Paste
⑤	Wire	Au Wire (Wire-bonding)
⑥	Molding	Non-fireproof epoxy resin(Transfer Mold)
⑦	Shield Case	Fe (Sn plated)

2) Functional Block Diagram

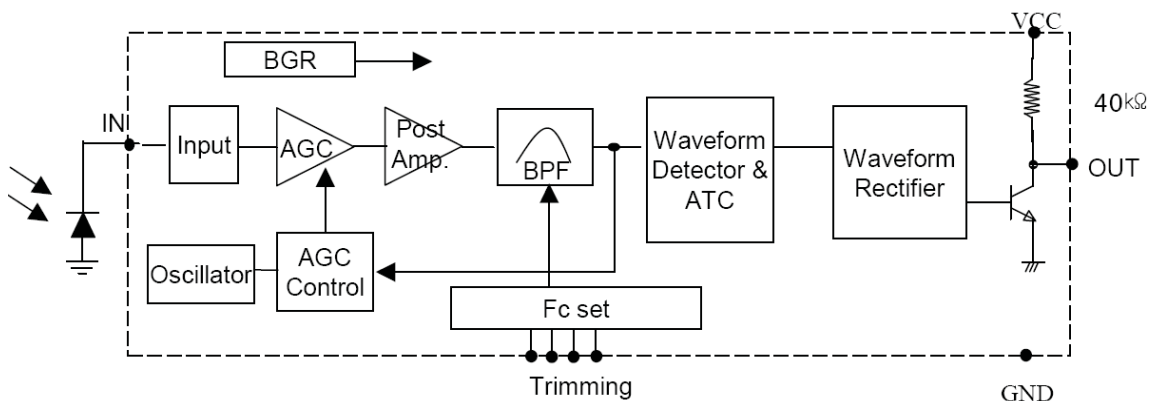

OPTO ELECTRONICS CO., LTD.

HEAD OFFICE & FACTORY (KOREA)

1066-12 YOUNJANG-RI, JINAN-UP, JINAN-GUN
JEON-BUK, KOREA.

TEL : (063) 433-4566~8 FAX : (063) 433-4569

E-mail : poweroec@e-oec.com

MANAGER	CHECK	APPROVAL
---------	-------	----------

FILE No.

OQSS-R-000

<h1>SPECIFICATIONS</h1>		SHEET No.	4 of 10
		DATE	2009. 05. 04.
PART NAME	IR RECEIVER MODULE	TYPE No.	R94FC2A
CODE No.		REVISION	A

3) Circuit Description of Function Block Diagram.

The function of the IC is described with above function block diagram.





Photo current generated by infrared radiation burst signal equivalently go through the Input pad of IC called "Input Block".

The DC part is separated in the coupling cap of the each amplifier and AC signal pass to a Pre-amplifier followed by an automatic gain control amplifier, a post amplifier and a band pass filter.

The final evaluation is done by a waveform detector & ATC, waveform rectifier stage.

The "automatic Gain control" is responsible for the dynamic control of stable working point to suppress the influences of disturbing sources. The digital output signal, which is an envelope signal of the incoming optical burst without the carrier frequency, has active low polarity, The detail of the each block is as below.

- ① **Input Block** reacts to the photo diode as a frequency-dependent load resistance.
- ② **AGC-Amplifier** generates most of the voltage gain of the whole circuitry whereby the amplification is controlled by Auto Gain Control block.
- ③ **Post-Amplifier** generates a signal gain to be fit to band pass filter input by limiting signal amplitude. The most of the voltage gain is decided by a ratio of load resistance and emitter resistance.
- ④ **Band Pass Filter** is an important part of the circuit to get a good performance in disturbed ambient. It is designed to achieve a specified frequency response and exhibit different characteristics depending on current value of each element.
- ⑤ **AGC Control & Oscillator** stage ensures that the receiver is immune to disturbances. It reacts to the noise or disturbance by changing the gain of the amplifier. In case of ambient light. The AGC sets the gain to the most sensitive value so that there is no unexpected output pulse, The AGC does not react to the useful data signal if signal gap time is enough. The AGC distinguishes useful data from disturbance signals and the distinguishing marks are burst length and envelope duty cycle.
- ⑥ **Waveform Detector & ATC** is consisted of two comparators. Compare with fixed threshold voltage in comparator 1'st receiving B.P.F filter's output and detect burst signal. Also, ATC changes comparator 2'nd threshold voltage level according to filter output signal size. This does function that protect that pulse width changes by size of filter output signals.
- ⑦ **Waveform Rectifier** is consisted of integrator and Schmitt-trigger. The integrator is triggered when the signal value reaches the comparator threshold voltage. It needs several cycles from the comparator output in series until the integrator is loaded and the output is triggered. The design of integrator and Schmitt Trigger is carried out so that the output pulse width is close to the optical burst length at the input.

 <p>OPTO ELECTRONICS CO., LTD. HEAD OFFICE & FACTORY (KOREA) 1066-12 YOUNJANG-RI, JINAN-UP, JINAN-GUN JEON-BUK, KOREA. TEL : (063) 433-4566~8 FAX : (063) 433-4569 E-mail : poweroec@e-oec.com</p>	MANAGER	CHECK	APPROVAL
			
	FILE No.	OQSS-R-000	

SPECIFICATIONS

SHEET No.	5 of 10
DATE	2009. 05. 04.
TYPE No.	R94FC2A
REVISION	A

PART NAME	IR RECEIVER MODULE
CODE No.	

8. Electro-Optical Characteristics

1) Absolute Maximum Ratings

Parameter	Symbol	Ratings	Unit
Supply Voltage	Vcc	7.0	V
Output Current	Iout	8	mA
Operating Temperature	Topr	-25 ~ +85	°C
Power Consumption	Ptot	30	mW
Storage Temperature	Tstg	-40 ~ +125	°C
Soldering Temperature (*1)	Tsol	270, t<5sec	°C

(*1) For 5sec (at mounting on PCB with thickness of 1.6mm)

2) Recommended operating Conditions

Parameter	Symbol	Ratings	Unit
Operating Voltage	Vcc	2.7 ~ 6.0	V
Input Frequency	fin	30 ~ 60	kHz

3) Electro-Optical Characteristics

Parameter	Symbol	Condition	Min	Typ	Max	Unit
Supply Voltage	Vcc		2.7	—	6.0	V
Supply Current	Icc	no signal input	0.5	1.0	1.5	mA
Peak Wavelength (*1)	λ_p		—	940	—	nm
B.P.F Center Frequency (*2)	fo		—	37.9	—	kHz
High Level Output Voltage (*1)	V _{OH}		4.8	5.0	—	V
Low Level Output Voltage (*1)	V _{OL}		—	0.2	0.4	V
High Level Output Pulse Width (*1)	t _{WH}	Burst Wave = 600 μ s Period = 1.2ms	500	600	700	μ s
Low Level Output Pulse Width (*1)	t _{WL}		500	600	700	μ s
Arrival Distance (*1)	D	$\pm 0^\circ$	20	—	—	m
		$\pm 30^\circ$	15	—	—	m
Output Form	Active Low Output					

* 1. 600/600us burst wave is transmitted by standard(fig. 2, fig. 3) transmitter. However, it measured after the initial transmission pulse is 10(60ms) pulse

* 2. The following band pass frequencies are available (32.7kHz / 36.7kHz / 37.9kHz / 40.0kHz)
carrier frequencies are adjusted by zener-diode fusing method.



OPTO ELECTRONICS CO., LTD.

HEAD OFFICE & FACTORY (KOREA)

1066-12 YOUNJANG-RI, JINAN-UP, JINAN-GUN
JEON-BUK, KOREA.

TEL : (063) 433-4566 ~ 8 FAX : (063) 433-4569

E-mail : poweroec@e-oec.com

MANAGER	CHECK	APPROVAL
FILE No.	OQSS-R-000	

SPECIFICATIONS

SHEET No.	6 of 10
DATE	2009. 05. 04.
PART NAME	IR RECEIVER MODULE
TYPE No.	R94FC2A
CODE No.	
REVISION	A

4) Measurement Conditions

① Fig.1 Burst wave, Output wave

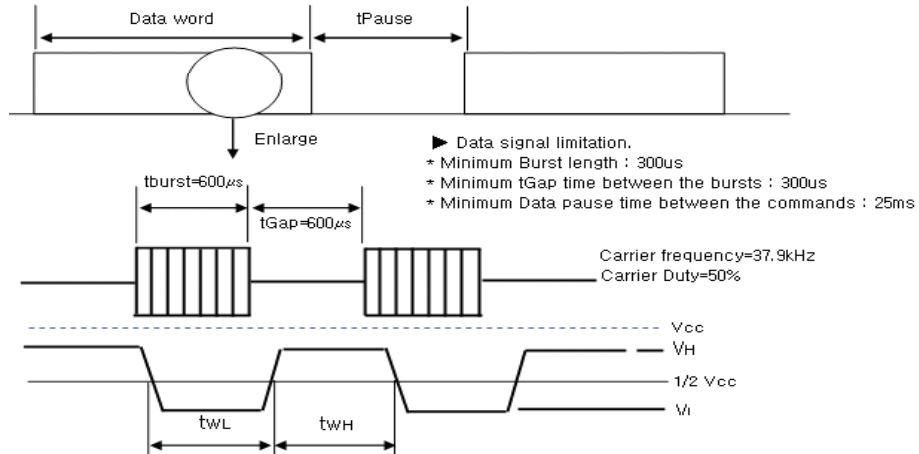

② Fig.2 Application Circuit

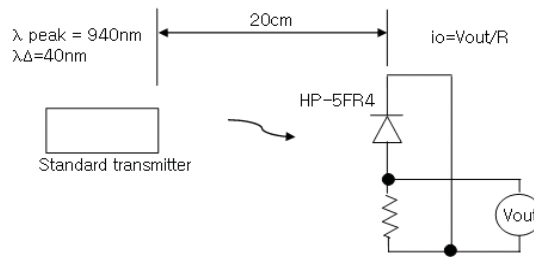

when standard transmitter output the signal at Fig.1 standard photodiode output $i_o=5\mu A_{p-p}$ under the measurement condition Fig.2. (The radiant intensity of standard transmitter : 50mW/sr)
 HP-5FR4 : standard photodiode has short current $I_{sc}=32\mu A$ at $E=1000(lx)$

③ Fig.3 Test Condition of Arrival Distance

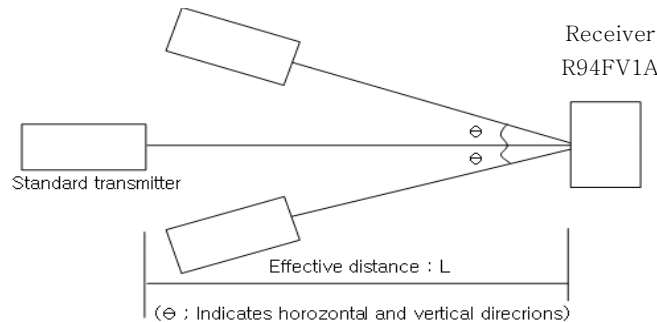

☞ Ambient light source : Detecting surface's illumination shall be 100Lux under ordinary white fluorescence lamp without high frequency lighting.



OPTO ELECTRONICS CO., LTD.

HEAD OFFICE & FACTORY (KOREA)
 1066-12 YOUNJANG-RI, JINAN-UP, JINAN-GUN
 JEON-BUK, KOREA.
 TEL : (063) 433-4566~8 FAX : (063) 433-4569
 E-mail : poweroec@e-oec.com

MANAGER	CHECK	APPROVAL
FILE No.	OQSS-R-000	

SPECIFICATIONS

SPECIFICATIONS		SHEET No.	7 of 10
		DATE	2009. 05. 04.
PART NAME	IR RECEIVER MODULE	TYPE No.	R94FC2A
CODE No.		REVISION	A

4) Disturbance Suppression

When a disturbance signal is applied to the R94FV1A.,Series. It can receive the data signal. However the sensitivity is reduced to that level that no unexpected pulses will occur. Some examples for such disturbance signals which are suppressed by the R94FV1A.. Series :

- a. Signals from fluorescent lamps with electronic ballast (please refer to Fig.1)
- b. Continuous signal at 37.9kHz or at any other frequency
- c. DC light (from tungsten lamp or sunlight)

[Fig.1 Fluorescent Lamp with Modulation]

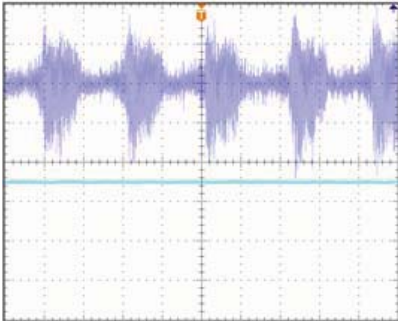

The signals shown in [Fig. 1] comes from a fluorescent lamp with electronic ballast Which is operated at 120Hz power line frequency.

A different kind of disturbance signal is caused by fluorescent lamps with electronic ballast.

Typically the oscillating frequency of the optical disturbance signal of such lamps is in the range between 20kHz and 50kHz. This frequency is twice of the electrical oscillating frequency of the driver circuit in the lamp ballast.

All R94FV1A. Series IR receiver modules can suppress such disturbance signals efficiently.

There will be no unexpected output pulses due to such lamps. However, sensitivity will be reduced according to the strength of the disturbance signal. More critical are the electronic ballasts with high modulation of the oscillating amplitude are more critical.



6) Cautions

- ① The performance of remote control system depends on environment condition and ability of peripheral parts. Thus, it is highly recommended to evaluate the performance of the receiver module. using the final product after the receiver module is assembled with peripheral components such as resistor, condenser, MICOM, and so on.
- ② The ripple noise from power supply line may shorten detecting distance of IR receiver module. Thus, in order to ensure more reliable operation, please add RC filter (R=100Ω, C=47μF) between Vcc and GND.
- ③ Store and use whenre there is no force causing transformation or change in quality.
- ④ Store and use where there is no extreme humidity.
- ⑤ In order to prevent damage from static electricity, make sure that the human body and the soldering iron are connected to ground before using.
- ⑥ In order to prevent electrostatic discharge of integrated circuit, human body and soldering iron, etc. shall be grounded.
- ⑦ Please use this device away from the dew drop.
Be aware that a dew drop rusts shield case and others, and it may affect the normal operation.



OPTO ELECTRONICS CO., LTD.

HEAD OFFICE & FACTORY (KOREA)
 1066-12 YOUNJANG-RI, JINAN-UP, JINAN-GUN
 JEON-BUK, KOREA.
 TEL : (063) 433-4566~8 FAX : (063) 433-4569
 E-mail : poweroec@e-oec.com

MANAGER	CHECK	APPROVAL
		
FILE No.	OQSS-R-000	

SPECIFICATIONS

SPECIFICATIONS		SHEET No.	8 of 10
		DATE	2009. 05. 04.
PART NAME	IR RECEIVER MODULE	TYPE No.	R94FC2A
CODE No.		REVISION	A

7) Graph of Electrical/Optical Characteristics

[Fig.1] Supply Current vs. Voltage

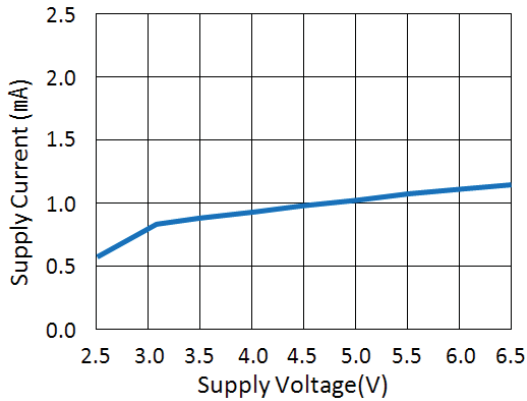

[Fig.2] Sensitivity vs. Supply Voltage

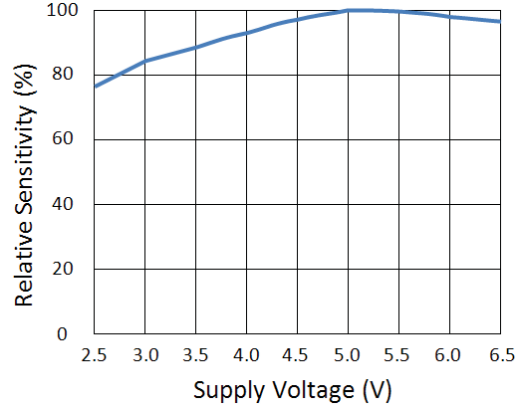

[Fig.3] Output Pulse Width vs. Distance

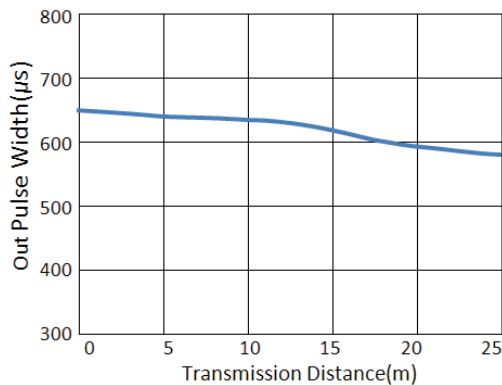

[Fig.4] Relative Sensitivity vs. Direction

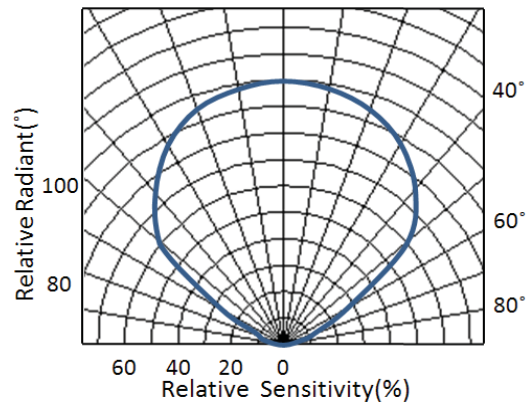



8) Standard Inspection

All output products shall be inspected based on following items.

- ① Detecting distance.
- ② Current consumption.
- ③ High level output voltage.
- ④ Low level output voltage.
- ⑤ Output Pulse Width.

9) Others

In case any trouble or question arise, both parties gree to make full discussion covering the said problem.

 <p>OPTO ELECTRONICS CO., LTD. HEAD OFFICE & FACTORY (KOREA) 1066-12 YOUNJANG-RI, JINAN-UP, JINAN-GUN JEON-BUK, KOREA. TEL : (063) 433-4566 ~ 8 FAX : (063) 433-4569 E-mail : poweroec@e-oec.com</p>	MANAGER	CHECK	APPROVAL	
				
	FILE No.	OQSS-R-000		

SPECIFICATIONS

SPECIFICATIONS		SHEET No.	9 of 10
		DATE	2009. 05. 04.
PART NAME	IR RECEIVER MODULE	TYPE No.	R94FC2A
CODE No.		REVISION	A

9. Reliability Test Item and Standard.

- 1) All output products shall satisfy below Reliability test items.
- 2) Related sampling quantity and acceptance/failure judgment standard accordance with MIL standard MIL-STD-833 is as listed below.

① Confidence level : 90%

② LTPD : 10% / 20%

No.	Test Item	Test Conditions	Judgment Standard	Fail@ amples(n)
1	High Temp. Storage (※ 2)	Ta=+120℃, t=480hr	High level output voltage VOH(Vcc=5.0V) VOH>4.5V Low level output voltage VOL (Vcc=5.0V) VOL<0.4V lcc (Vcc=5.0V) lcc<1.5mA D (Vcc=5.0V) Arrival Distance D>15m	C=0 / n=22
2	Low Temp. Storage (※ 2)	Ta=-30℃, t=480hr		C=0 / n=22
3	High Temp. bias (※ 1, ※ 2)	Ta=+85℃, t=480hr		C=0 / n=22
4	High Temp./ High Hum. (※ 2)	Ta=+85℃, 90%RH t=480hr		C=0 / n=22
5	Temperature Cycle (※ 2, ※ 3)	Ta=-20℃(0.5hr) to +85℃(0.5hr) 20cycle		C=0 / n=22
6	P.C.T (※ 2)	Ta=+121℃ 100%RH, P=2atm, t=4hr		C=0 / n=22
7	Solder Heat (※ 2, ※ 5)	Ta=+270±5℃, 5s Pb free solder : Sn/Cu		C=0 / n=11
8	Variable frequency vibration (※ 2)	Frequency range : 10 to 55hz/sweep 1min Overall amplitude : 1.5mm X,Y,Z/2h each		C=0 / n=11
9	Falling (※ 4)	Height=75cm, 3 times		C=0 / n=11
10	Operating life (※ 1)	Ta=+25℃, t=1,000hr		C=0 / n=11
11	Solderability (※ 5)	Soldering Temp.: +230±5℃, 5s		Leads shall be covered By solder more than 95%

- ※1. Supply voltage of load test is 5V.(Standard Jig of OEC)
- ※2. Electro-optical characteristics shall be satisfied after leaving 2 hours in the normal condition.
- ※3. Temperature cycle test shall repeat above condition 20 times under no load.
- ※4. The test devices shall be dropped three time on the hard wooden board from a height of 75cm.
- ※5. For 5sec (after mounting on PCB with thickness of 1.6mm)

In cased any trouble or question arises related to above test items, both parties agree to make full discussion and covering the said matters.

 OPTO ELECTRONICS CO., LTD. HEAD OFFICE & FACTORY (KOREA) 1066-12 YOUNJANG-RI, JINAN-UP, JINAN-GUN JEON-BUK, KOREA. TEL : (063) 433-4566 ~ 8 FAX : (063) 433-4569 E-mail : poweroec@e-oec.com	MANAGER	CHECK	APPROVAL
			
	FILE No.	OQSS-R-000	

SPECIFICATIONS



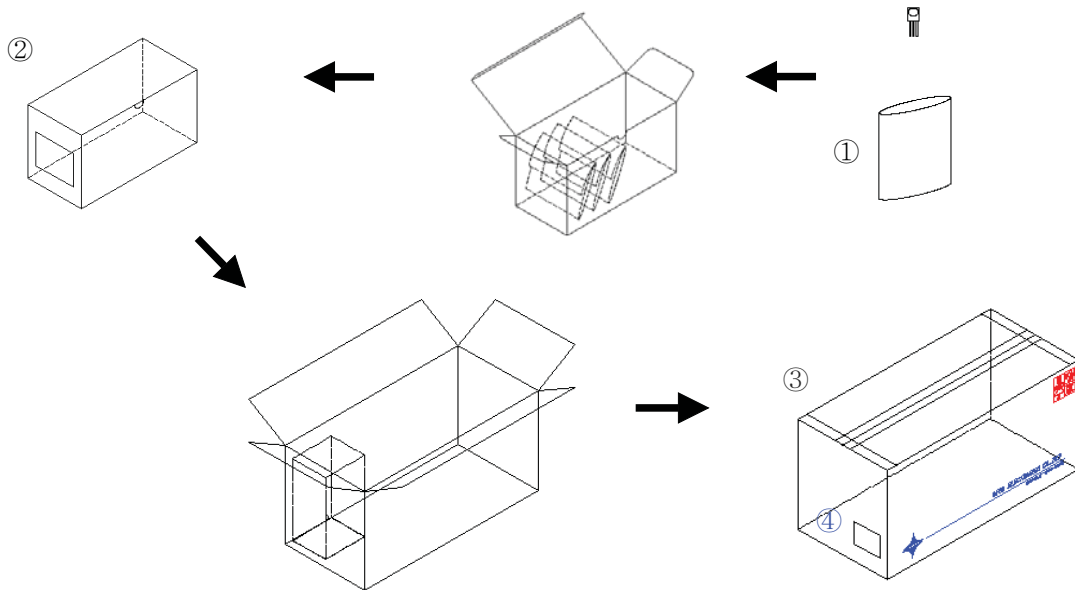

SPECIFICATIONS		SHEET No.	10 of 10
		DATE	2009. 05. 04.
PART NAME	IR RECEIVER MODULE	TYPE No.	R94FC2A
CODE No.		REVISION	A

No.	Part name	Dimensions(mm)	Quantity(pcs)
①	Anti-electrostatic tray	-	100
②	Inner box	235×130×110	1,000
③	Out box	575×285×265	10,000
④	Standard label	 <p style="font-size: small;"> Part NO. : XXXX-XXXXXX 품명 및 규격 : REMOCON MODULE / XXXXXX Q'ty : XXXXX pcs 업체명 : ㈜원광전자 제조일자 : 200X년 XX월 XX일 </p>	

10. Packing Example



"Quantity" is the maximum quantity which we can pack.

	OPTO ELECTRONICS CO., LTD. HEAD OFFICE & FACTORY (KOREA) 1066-12 YOUNJANG-RI, JINAN-UP, JINAN-GUN JEON-BUK, KOREA. TEL : (063) 433-4566 ~ 8 FAX : (063) 433-4569 E-mail : poweroec@e-oec.com	MANAGER	CHECK	APPROVAL
				
	FILE No.	OQSS-R-000		