



## Technical Data Sheet

### Side Face Infrared LED

#### IR928-6C

#### Features

- High reliability
- High radiant intensity
- Peak wavelength  $\lambda_p=940\text{nm}$
- 2.54mm Lead spacing
- Low forward voltage
- Pb free



#### Descriptions

- EVERLIGHT's Infrared Emitting Diode IR928-6C is a high intensity diode, molded in a water clear plastic package.
- The miniature side-facing device has a chip, that emits radiation from the side of the clear package.

#### Applications

- Mouse
- Optoelectronic switch
- Infrared applied system

#### Device Selection Guide

LED Part No.	Chip	Lens Color
	Material	
IR	GaAlAs	Water clear

**Package Dimensions**

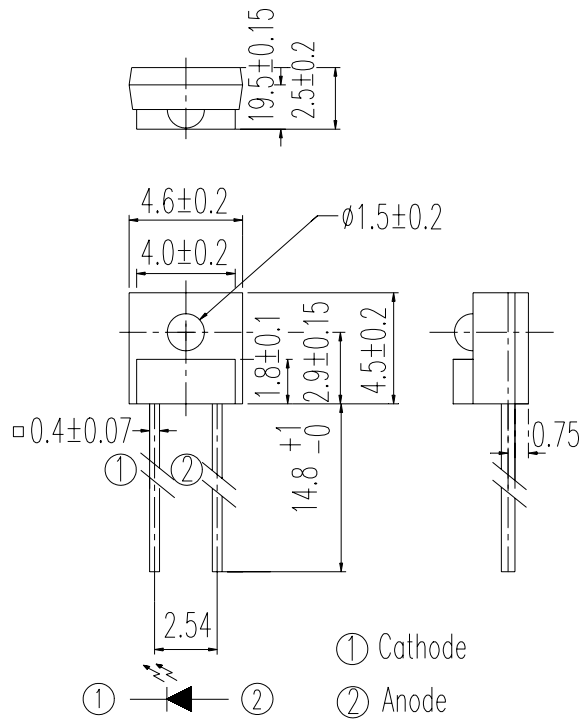

- Notes:** 1.All dimensions are in millimeters  
2.Tolerances unless dimensions  $\pm 0.25\text{mm}$

**Absolute Maximum Ratings (Ta=25°C)**

Parameter	Symbol	Rating	Units
Continuous Forward Current	$I_F$	100	mA
Peak Forward Current	$I_{FP}$	1.0	A
Reverse Voltage	$V_R$	5	V
Operating Temperature	$T_{opr}$	-40 ~ +85	°C
Storage Temperature	$T_{stg}$	-40 ~ +85	°C
Soldering Temperature	$T_{sol}$	260	°C
Power Dissipation at(or below) 25°C Free Air Temperature	$P_d$	150	mW

- Notes:** \*1: $I_{FP}$  Conditions--Pulse Width  $\leq 100 \mu s$  and Duty  $\leq 1\%$ .  
\*2:Soldering time  $\leq 5$  seconds.

**Electro-Optical Characteristics (Ta=25°C)**

Parameter	Symbol	Condition	Min.	Typ.	Max.	Units
Light Current	Ic(ON)	I <sub>F</sub> =4mA, V <sub>CE</sub> =3.5V	350	--	710	μA
		I <sub>F</sub> =5mA, V <sub>ON</sub> =5V	20	--	50	
Peak Wavelength	λ <sub>p</sub>	I <sub>F</sub> =20mA	--	940	--	nm
Spectral Bandwidth	Δλ	I <sub>F</sub> =20mA	--	45	--	nm
Forward Voltage	V <sub>F</sub>	I <sub>F</sub> =20mA		1.2	1.5	V
		I <sub>F</sub> =100mA Pulse Width ≤ 100 μs, Duty ≤ 1%	--	1.4	1.8	
		I <sub>F</sub> =1A Pulse Width ≤ 100 μs, Duty ≤ 1%.	--	2.6	4.0	
Reverse Current	I <sub>R</sub>	V <sub>R</sub> =5V	--	--	10	μA
View Angle	2θ 1/2	I <sub>F</sub> =20mA	--	60	--	deg

**Rank**

 Condition : I<sub>F</sub>=4mA V<sub>ce</sub>=3.5V

Color Code	Parameter	Min	Max	Unit
Red	E1	140	260	μA
Blue	E2	210	350	μA
Yellow	E3	280	440	μA
Silver	E4	350	530	μA
Green	E5	420	620	μA
Purple	E6	490	710	μA
White	E7	560	800	μA
Brown	E8	630	890	μA
Orange	E9	700	980	μA

**Rough Ranks**

Parameter	Min	Max	Unit
7-2	300	450	μA
7-1	340	520	μA
6-2	490	750	μA
6-1	650	1300	μA

**Typical Electro-Optical Characteristics Curves**

Fig.1 Forward Current vs. Ambient Temperature

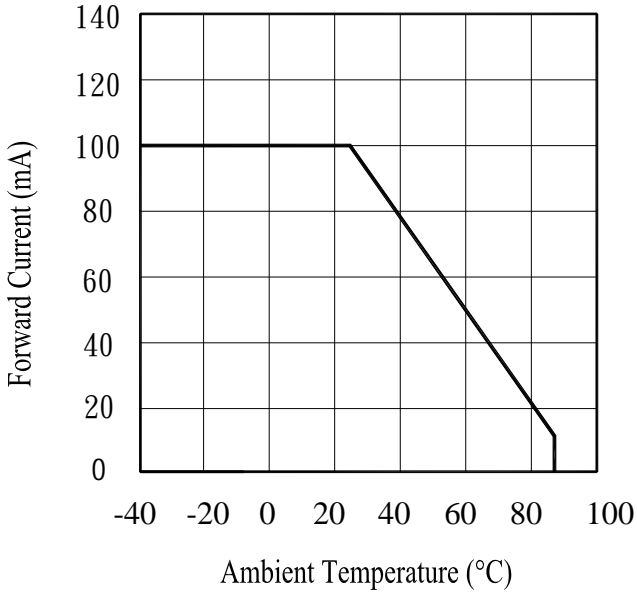

Fig.2 Spectral Distribution

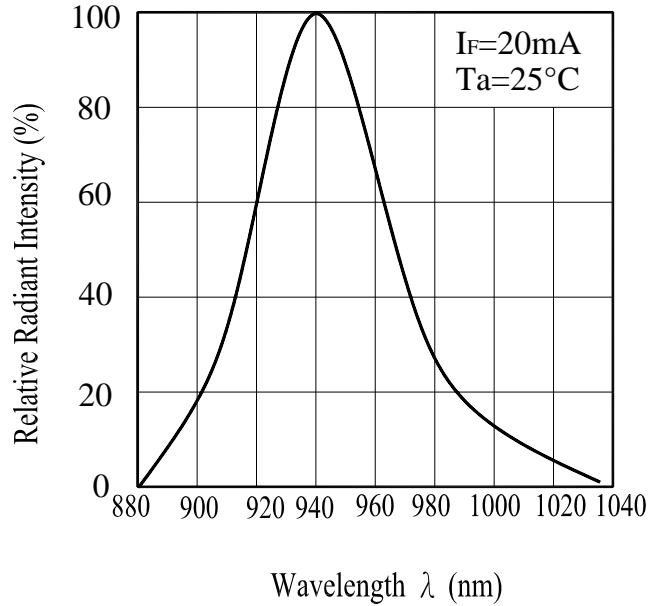

Fig.3 Peak Emission Wavelength vs. Ambient Temperature

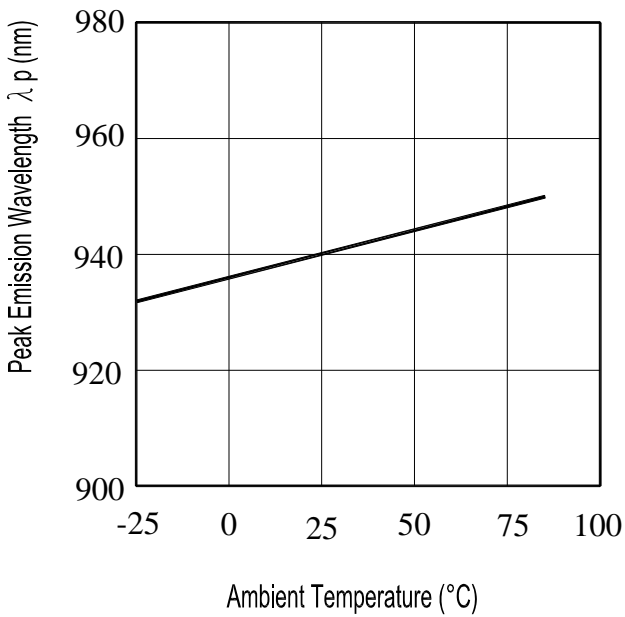
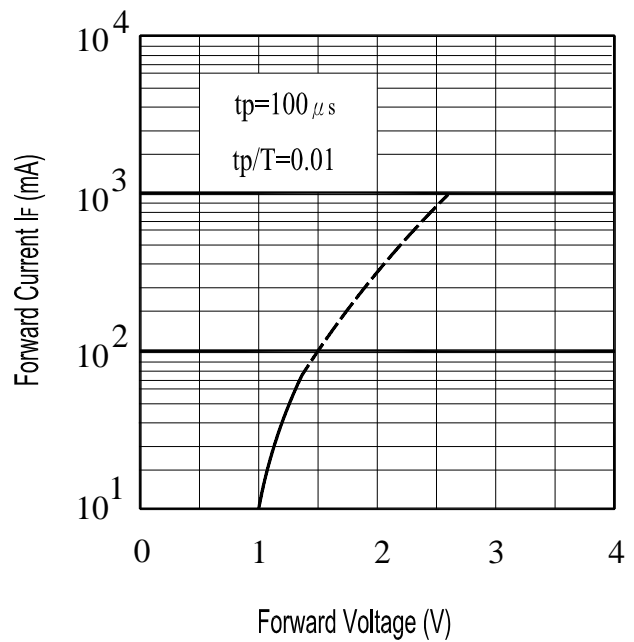

Fig.4 Forward Current vs. Forward Voltage



**Typical Electro-Optical Characteristics Curves**

Fig.5 Relative Intensity vs.

Forward Current

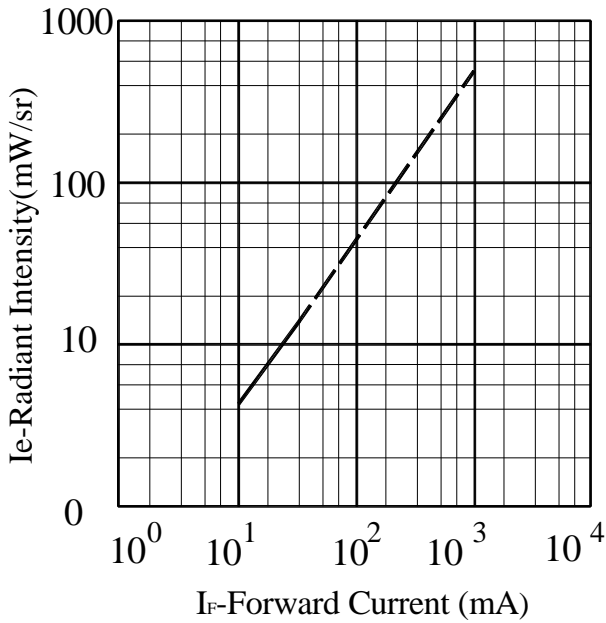

Fig.6 Relative Radiant Intensity vs.

Angular Displacement

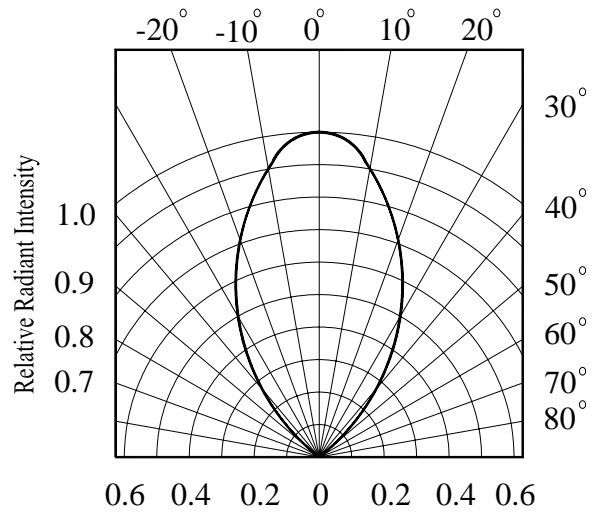

Fig.7 Relative Intensity vs.

Ambient Temperature(°C)

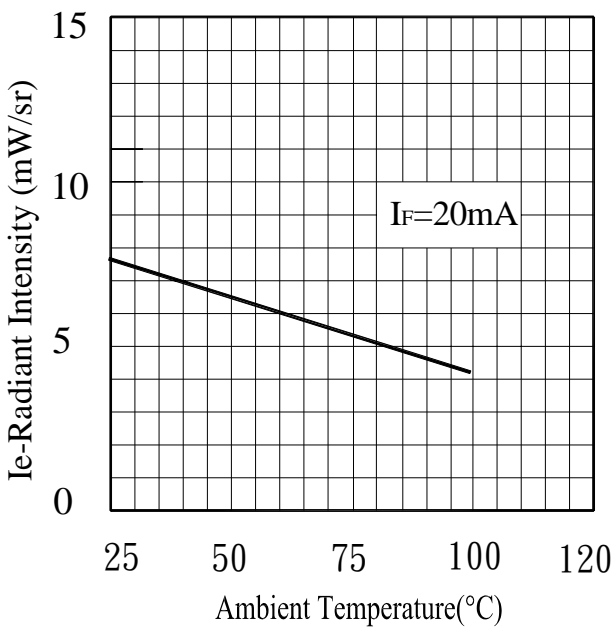
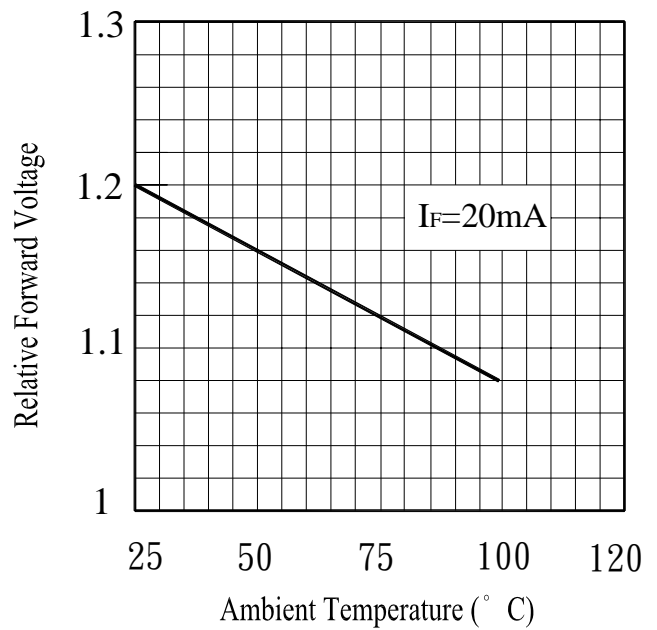

Fig.8 Forward Current vs.

Ambient Temperature(°C)



**Reliability Test Item And Condition**

The reliability of products shall be satisfied with items listed below.

Confidence level : 90%

LTPD : 10%

NO.	Item	Test Conditions	Test Hours/ Cycles	Sample Sizes	Failure Judgement Criteria	Ac/Re
1	Solder Heat	TEMP. : 260°C±5°C	10secs	22pcs	$I_R \geq U \times 2$ $E_e \leq L \times 0.8$ $V_F \geq U \times 1.2$  U : Upper Specification  Limit L : Lower Specification Limit	0/1
2	Temperature Cycle	H : +85°C     30mins ↑ 5mins ↓ L : -55°C     30mins	50Cycles	22pcs		0/1
3	Thermal Shock	H : +100°C    5mins ↑ 10secs ↓ L : -10°C     5mins	50Cycles	22pcs		0/1
4	High Temperature Storage	TEMP. : +100°C	1000hrs	22pcs		0/1
5	Low Temperature Storage	TEMP. : -55°C	1000hrs	22pcs		0/1
6	DC Operating Life	$I_F=20mA$	1000hrs	22pcs		0/1
7	High Temperature/ High Humidity	85°C / 85% R.H	1000hrs	22pcs		0/1

**Packing Quantity Specification**

1. 1000PCS/1Bag,10Bag/1Box
2. 10Boxes/1Carton

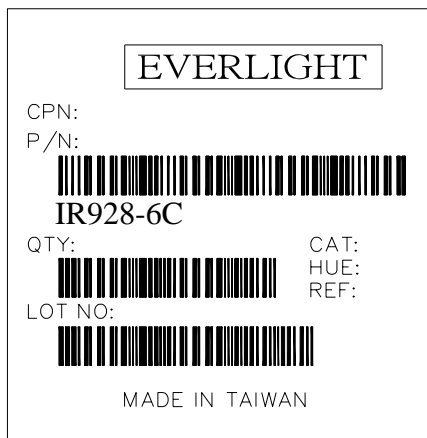
**Label Form Specification**

CPN: Customer's Production Number  
P/N : Production Number  
QTY: Packing Quantity  
CAT: Ranks  
HUE: Peak Wavelength  
REF: Reference  
LOT No: Lot Number  
MADE IN TAIWAN: Production Place

**Notes**

1. Above specification may be changed without notice. EVERLIGHT will reserve authority on material change for above specification.
2. When using this product, please observe the absolute maximum ratings and the instructions for using outlined in these specification sheets. EVERLIGHT assumes no responsibility for any damage resulting from use of the product which does not comply with the absolute maximum ratings and the instructions included in these specification sheets.
3. These specification sheets include materials protected under copyright of EVERLIGHT corporation. Please don't reproduce or cause anyone to reproduce them without EVERLIGHT's consent.

**EVERLIGHT ELECTRONICS CO., LTD.**  
Office: No 25, Lane 76, Sec 3, Chung Yang Rd,  
Tucheng, Taipei 236, Taiwan, R.O.C

Tel: 886-2-2267-2000, 2267-9936  
Fax: 886-2267-6244, 2267-6189, 2267-6306  
<http://www.everlight.com>